

SPG12

Planetary gearhead

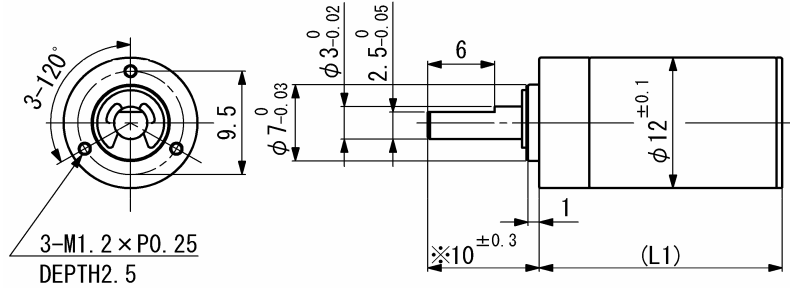

Dimension in mm

Note) Dimension marked ※ is measured with shaft pushed against gearhead.

For combination with motors: SCL12-20, SCL12-22, SCL12-30

General specifications

	SPG12	
Housing material	Metal	
Geartrain material	Steel	
Recommended max. input speed	8000	rpm
Operating temperature range	-10...+60	°C
Backlash at no-load per stage	≤ 1	°
Bearings on output shaft	Sintered sleeve bearings	
Max. shaft radial load (7 mm from flange)	4 (25)	N
Max. shaft axial load	2	N
Max. shaft press fit force	30	N
Shaft radial play	≤ 0.03	mm
Shaft axial play	≤ 0.3	mm

In parenthesis the max. radial load with ball bearing option.

Ratio (nominal)	Stage	Gearhead length, L1 [mm]	Gearhead weight [g]	Max. allowable torque [mNm]		Length with motor [mm]			Efficiency [%]	Direction of rotation
				Continuous	Intermittent	SCL12-20	SCL12-22	SCL12-30		
3.5 : 1	1	14.2	11.6	100	200	35.2	37.2	46.2	85	=
4.8 : 1	1	14.2	11.6	100	200	35.2	37.2	46.2	85	=
12 : 1	2	18	14.1	100	200	39	41	50	72	=
23 : 1	2	18	14.1	100	200	39	41	50	72	=
58 : 1	3	21.8	16.6	100	200	42.8	44.8	53.8	61	=
107 : 1	3	21.8	16.6	100	200	42.8	44.8	53.8	61	=
509 : 1	4	25.7	19.1	100	200	46.7	48.7	57.7	52	=

V01

Namiki Precision Jewel Co.,Ltd

TEL: +81-3-5390-7619 FAX: +81-3-5390-8082

URL: www.namiki.net/

E-mail: kboinfo@namiki.net

Specifications subject to change without notice

SSG12

Spur gearhead

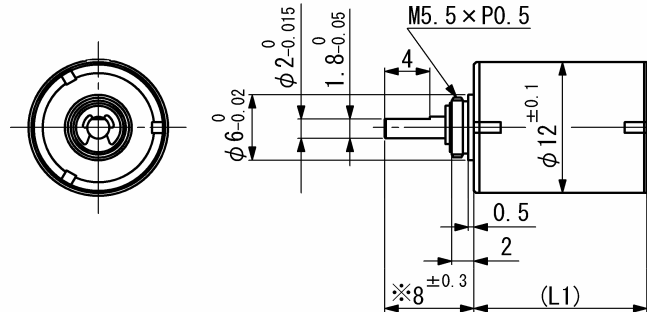

Dimension in mm

Note) Dimension marked ※ is measured with shaft pushed against gearhead.

For combination with motors: SCL12-20, SCL12-22, SCL12-30

General specifications	SSG12	
Housing material	Metal	
Geartrain material	Metal	
Recommended max. input speed	8000	rpm
Operating temperature range	-10...+60	°C
Max. backlash at no-load, 5 stages	≤ 5	°
Bearings on output shaft	Sintered sleeve bearings	
Max. shaft radial load (10 mm from flange)	3	N
Max. shaft axial load	1	N
Max. shaft press fit force	20	N
Shaft radial play	≤ 0.03	mm
Shaft axial play	≤ 0.2	mm

Ratio (nominal)	Stage	Gearhead length, L1 [mm]	Gearhead weight [g]	Max. allowable torque [mNm]		Length with motor [mm]			Efficiency [%]	Direction of rotation
				Continuous	Intermittent	SCL12-20	SCL12-22	SCL12-30		
16 : 1	3	14	8.3	12	30	35	37	46	73	≠
25 : 1	3	14	8.3	12	30	35	37	46	73	≠
47 : 1	4	16	9.2	15	30	37	39	48	66	=
74 : 1	4	16	9.2	15	30	37	39	48	66	=
94 : 1	4	16	9.2	15	30	37	39	48	66	=
175 : 1	5	18	10.2	15	30	39	41	50	59	≠
282 : 1	5	18	10.2	15	30	39	41	50	59	≠

V01

Namiki Precision Jewel Co.,Ltd

TEL: +81-3-5390-7619 FAX: +81-3-5390-8082

URL: www.namiki.net/

E-mail: kboinfo@namiki.net

Specifications subject to change without notice